

QUIKER 10

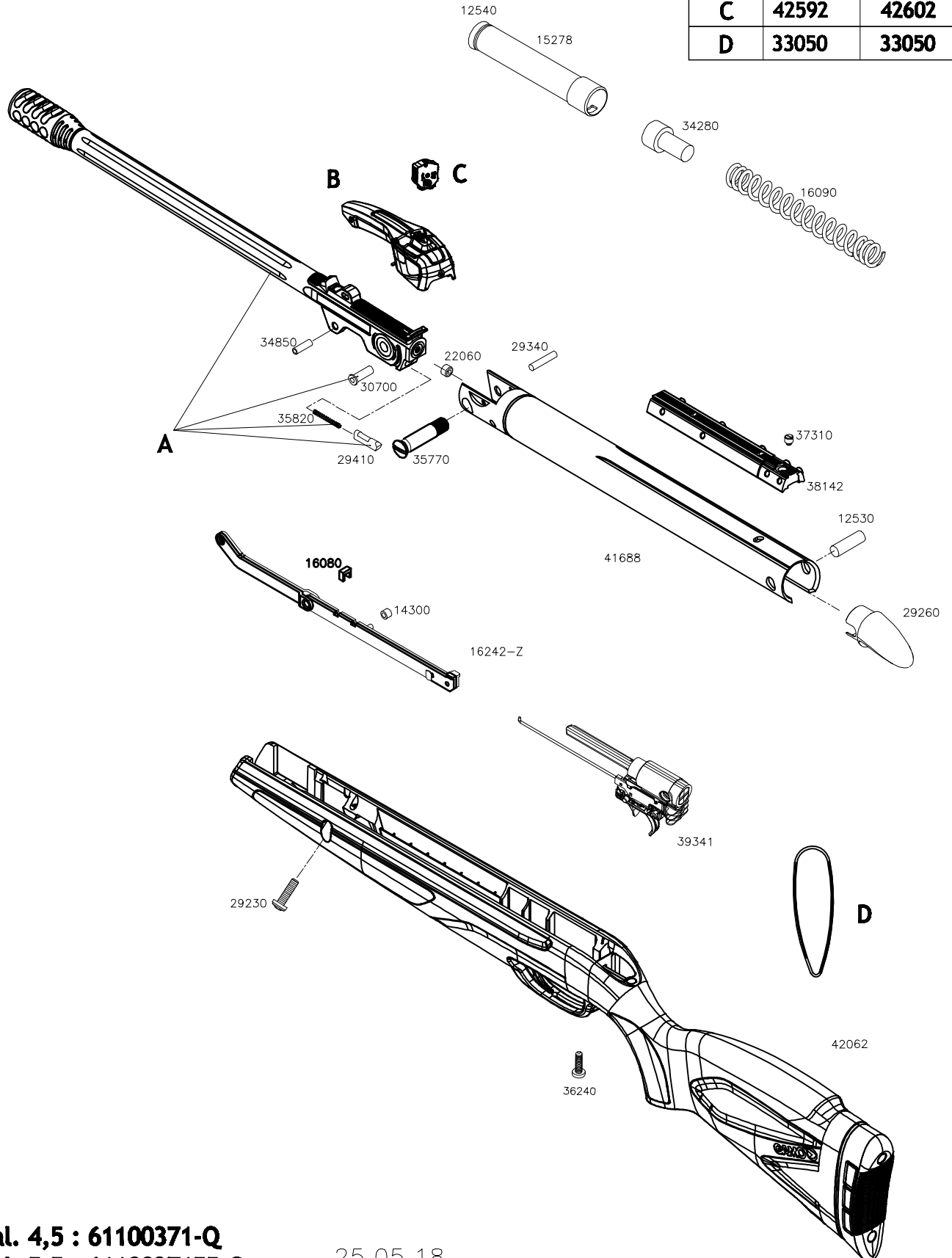

Ref.	Cal. 4,5	Cal. 5,5
A	42102-R	42112-R
B	41762	41772
C	42592	42602
D	33050	33050



Ref. Cal. 4,5 : 61100371-Q
 Ref. Cal. 5.5 : 6110037155-Q

25.05.18